

M12 male 0°/M12 female 0° shielded B-cod.Profibus

PUR 1x2xAWG22 shielded vt UL/CSA+drag chain 2m

PROFIBUS

Male straight – female straight

M12, 4-pole – M12, 2-pole

B-coded

shielded

Plastic housings with good resistance against chemicals and oils.

The resistance to aggressive media should be individually tested for your application. Further details on request.

Further cable lengths on request.

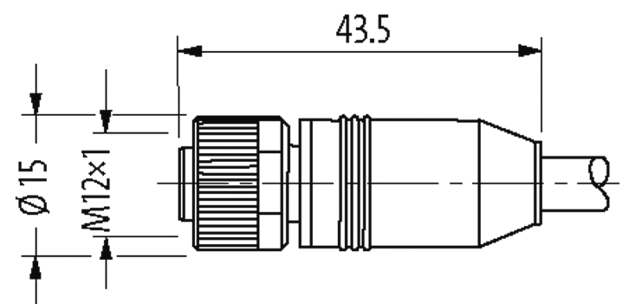
Illustration

Product may differ from Image

Approvals

cCSAus



* only for products with UL/CSA approved cable

More Info



Form

Form 44001

Cables

Cable number	786
No./diameter of wires	1 × 2× AWG22
Wire isolation	PE (rd, gn)
C-track properties	2 Mio.
Jacket Color	violet
Material (jacket)	PUR (UL/CSA)
Outer Ø	8.1 mm ±5%
Bend radius (moving)	12× outer Ø
Temperature range (fixed)	-40...+80 °C
Temperature range (mobile)	-20...+60 °C
Cable identification	786
Approval (cable)	UL (AWM-Style 20233/10578), CSA; CE
Cable weight [g/m]	81,40
Material (wire)	Cu wire, bare
Resistor (core)	max. 55 Ω/km (20 °C)
Single wire Ø (core)	0.16 mm
Construction (core)	19× 0.16 mm (multi-strand wire class 5)
Diameter (core)	1 × 2× AWG22
Material (wire isolation)	PE
Wire-Ø incl. isolation	2.85 mm ±5%
Color/numbering of wires	rd, gn
Shield	yes
	min. 85%
Material (jacket)	PUR
Outer-Ø (jacket)	8.1 mm ±5%
Color (jacket)	violet
Nominal voltage	300 V
Temperature range (fixed)	-40...+80 °C
Temperature range (mobile)	-20...+60 °C
Bend radius (fixed)	6× outer Ø
Bend radius (moving)	12× outer Ø
Travel speed (C-track)	max. 3 m/s
Acceleration (C-track)	max. 3 m/s²

Technical Data

Operating voltage max. 60 V AC/DC

Operating voltage (only UL listed)	max. 30 V AC/DC
Rated surge voltage	1.5 kV
Operating current per contact	max. 4 A
Material group	IEC 60664-1, category I
Coding	B-coded
Locking of ports	Screw thread (M12×1 mm) recommended torque 0.6 Nm, self-securing
Compression gland	M12 (SW13)
Protection	IP65, IP66K, IP67 inserted and tightened (EN 60529)
Locking material	Zinc die casting, matte nickel plated
Material	PUR
suitable for corrugated tube (internal Ø)	without

General data

Standards	DIN EN 61076-2-101 (M12)
Mounting method	inserted, tightened
Pollution Degree	3
Temperature range	-25...+85 °C, depending on cable quality

Commercial data

country of origin	DE
customs tariff number	85444290
EAN	4048879629492
eClass	27061801
Packaging unit	1